

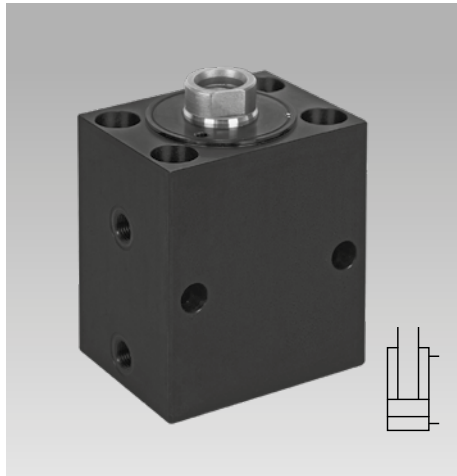

Block Cylinders S

double acting, max. operating pressure 250 bar and 500 bar
use as punching cylinder max. 250 bar



5 sizes

5 seal variants

4 stroke lengths

Pressure stages 250 and 500 bar
Temperature optimised -30 ... +200 °C
250 °C on request

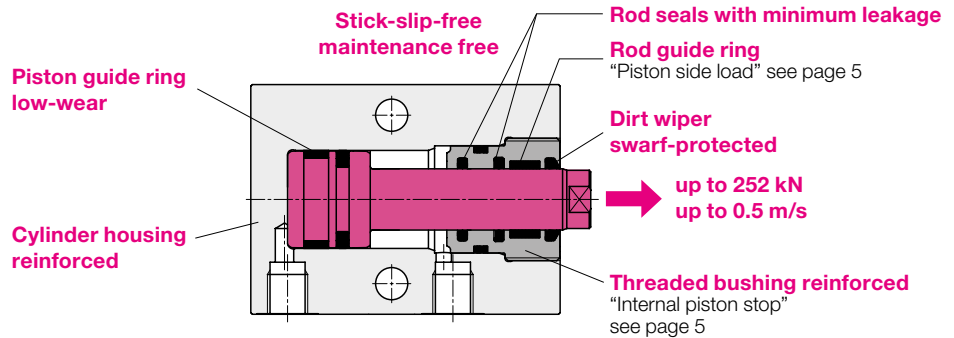

Application

Hydraulic block cylinders are universally used for all linear movements with high force requirements and very small dimensions.

The block cylinder S can withstand high mechanical and thermal loads. Its preferred applications are:

- Punching*)
- Deburring
- Forming such as bending, riveting, stamping
- In mould making for actuating core pullers and slides
- In automatic manufacturing systems with very short cycle times

Fixing possibilities

Possible mounting holes

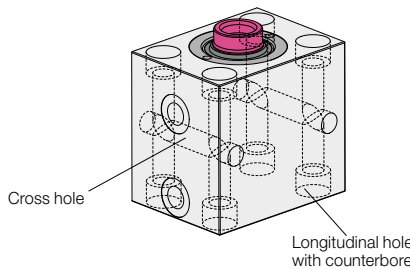

Hydraulic connecting possibilities

Pipe thread

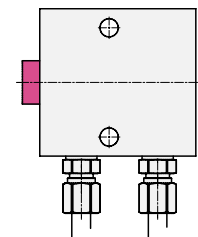

Function

The double-acting function ensures high function safety as well as exactly calculable and repeatable stroke times.

Description

The block cylinders S are equipped with the latest sealing technology, so that optimally adapted versions are available depending on the operating pressure (250 or 500 bar), temperature and hydraulic fluid.

At the piston rod outlet, the dirt wipers are largely protected against swarf by the recessed installation. All series are equipped with piston and rod guide rings which absorb side loads between the sliding components and prevent direct metal contact. This increases the service life and minimizes leakage. The admissible piston side load depends on the stroke and can be taken from the diagrams on page 5.

The internal piston stops are of sturdy design. The admissible piston speed depends on the mass fixed to the piston and can be read in the diagram on page 5.

Important notes see page 6.

*) Maximum operating pressure 250 bar
Required for punching applications due to the high load caused by the cutting impact. Even with the high-pressure version (500 bar), the pressure must be limited to 250 bar. The advantage of this is the longer service life of the high-pressure seals.

● Broad side

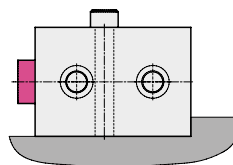

● Rod side

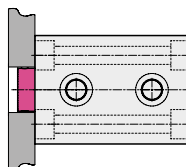

● Bottom side

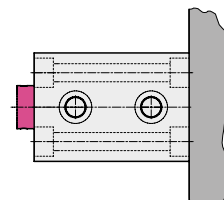

● Flange with O-ring sealing

● Broad side

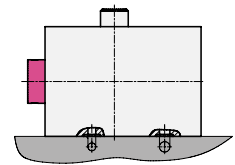

● Rod side

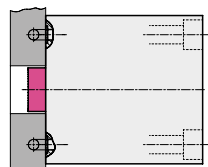

● Bottom side

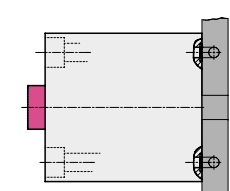

Pipe thread

2 cross holes

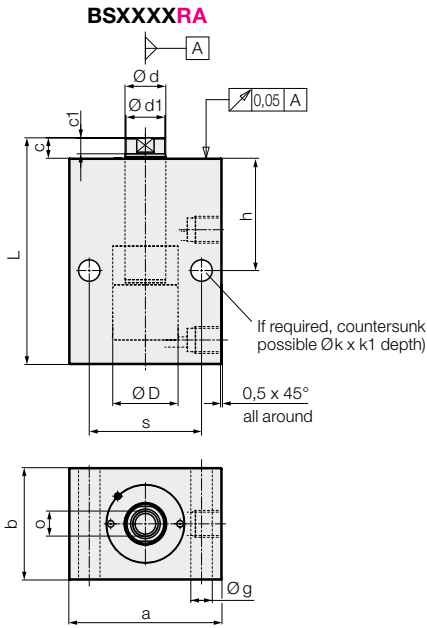

Fixing screws 8.8

2 cross holes and 4 longitudinal holes

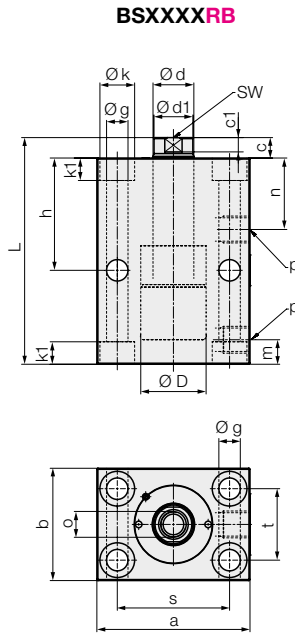

4 threads

at the rod side **BSXXXXRC**
at the bottom side **BSXXXXRC**

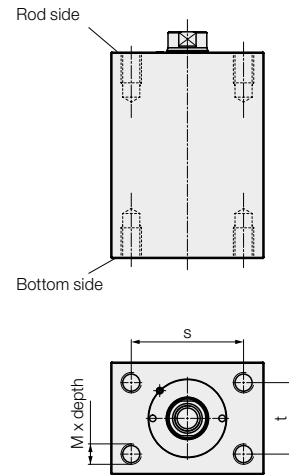

2 cross holes and keyway

Connection at the left side **BSXXXXRF**
Connection at the right side **BSXXXXRE**

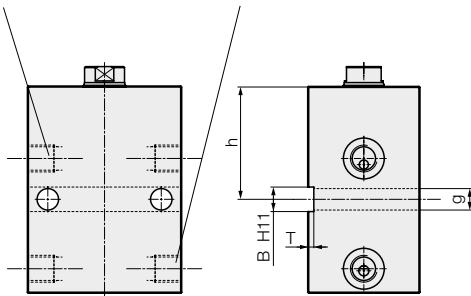

Piston with internal thread and housing with centring collar **BSXXXXRXXXXN2**

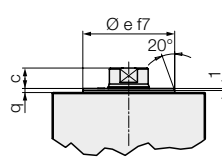

Centring collar only with housing RB and RC

Piston with external thread and housing without centring collar **BSXXXXRXXXXN3** with centring collar **BSXXXXRXXXXN4**

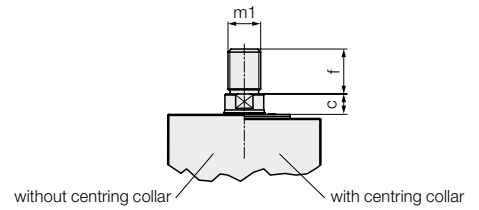

Materials

Cylinder housing: high alloy steel, black oxide
Piston: case-hardening steel, hardened and ground

Size		4	5	6	7	8
Piston Ø D	[mm]	32	40	50	63	80
Rod Ø d	[mm]	20	25	32	40	50
Stroke ± 0.4	[mm]	25	25	25	25	25
Total length L +0.7/-0.3	[mm]	111	116	127	145	159
Weight, approx.	[kg]	2.7	3.7	5.7	10	18.2
Part no.		BS4XXXRX025NX	BS5XXXRX025NX	BS6XXXRX025NX	BS7XXXRX025NX	BS8XXXRX025NX
Stroke ± 0.4	[mm]	50	50	50	50	50
Total length L +0.7/-0.3	[mm]	136	141	152	170	184
Weight, approx.	[kg]	3.3	4.6	6.9	11.8	21.1
Part no.		BS4XXXRX050NX	BS5XXXRX050NX	BS6XXXRX050NX	BS7XXXRX050NX	BS8XXXRX050NX
Stroke ± 0.4	[mm]	75	75	75	75	75
Total length L +0.9/-0.5	[mm]	161	166	177	195	209
Weight, approx.	[kg]	4	5.4	8	13.6	24
Part no.		BS4XXXRX075NX	BS5XXXRX075NX	BS6XXXRX075NX	BS7XXXRX075NX	BS8XXXRX075NX
Stroke ± 0.4	[mm]	100	100	100	100	100
Total length L +0.9/-0.5	[mm]	186	191	202	220	234
Weight, approx.	[kg]	4.6	6.2	9.1	15.4	26.8
Part no.		BS4XXXRX100NX	BS5XXXRX100NX	BS6XXXRX100NX	BS7XXXRX100NX	BS8XXXRX100NX

Example of ordering see page 6

Seal combination see page 3

Piston thread, centring collar

Housing identification see above

Size			4	5	6	7	8
Piston Ø D		[mm]	32	40	50	63	80
Rod Ø d		[mm]	20	25	32	40	50
Effective piston area	stroke to extend / stroke to retract	[cm ²]	8.04/4.9	12.56/7.65	19.63/11.59	31.17/18.6	50.26/30.63
Force to push at	100 bar	[kN]	8	12.6	19.6	31.1	50.3
	250 bar	[kN]	20.1	31.4	49	77.9	125.6
	500 bar	[kN]	40.2	62.8	98.1	155.8	251.3
Force to pull at	100 bar	[kN]	4.9	7.7	11.6	18.6	30.6
	250 bar	[kN]	12.25	19.1	29	46.5	76.5
	500 bar	[kN]	24.5	38.2	57.9	93	153.1
Oil volume per 10 mm	stroke to extend / stroke to retract	[cm ³]	8.04/4.9	12.56/7.7	19.63/11.6	31.17/18.6	50.26/30.6
Admissible flow rate for							
Pipe thread	stroke to extend / stroke to retract	[cm ³ /s]	400/250	630/380	980/580	1560/930	2500/1530
Flange F and B	stroke to extend / stroke to retract	[cm ³ /s]	280/170	460/280	550/320	1000/600	1600/975
Flange S	stroke to extend / stroke to retract	[cm ³ /s]	180/110	200/120	550/320	1000/600	1600/975
a		[mm]	75	85	100	125	160
b		[mm]	55	63	75	95	120
B H11		[mm]	12	12	15	20	24
c		[mm]	10	10	10	14	14
Ø d1 x c1		[mm]	19x7.8	24x7.6	31x8.2	38.7x10.2	48x10.2
Ø e f7		[mm]	45	56	65	80	105
f		[mm]	20	22	28	36	45
Øg		[mm]	10.5	10.5	13	17	21
h		[mm]	55	55	62	75	80
h1		[mm]	27	27	30	30	30
Øk		[mm]	17	17	20	26	33
k1		[mm]	11	11	13	17	21.5
m		[mm]	12	14	15	18	24
m1		[mm]	M14x1.5	M16x1.5	M20x1.5	M27x2	M33x2
M x depth			M10x15	M10x15	M12x18	M16x24	M20x30
n		[mm]	35	36	42	51	53
o x depth of thread		[mm]	M12x15	M16x25	M20x30	M27x40	M30x40
p		[mm]	G 1/4	G3/8	G3/8	G 1/2	G 1/2
q		[mm]	3	3	3	3	4
s		[mm]	55	63	76	95	120
t		[mm]	35	40	45	65	80
T		[mm]	3	3	5	5	7
SW		[mm]	17	21	27	36	41
u +/- 0.05		[mm]	1.1	1.1	1.1	1.5	1.5
u1 +/- 0.05		[mm]	1.1	1.1	1.1	1.5	1.5
Ø v1 extend		[mm]	5	6	6	8	8
Ø v2 retract		[mm]	4.5	4.5	6	6	8
Ø v3 extend		[mm]	4	4	6	8	8
Ø v4 retract		[mm]	4	4	6	6	8
Ø w +0.2		[mm]	9.8	9.8	10.8	13.8	13.8
Ø w1 +0.2		[mm]	7.8	7.8	9.8	13.8	13.8
x		[mm]	12	14	15	18	24
y		[mm]	38	39	45	54	55.5
z		[mm]	57	67	78	97	124

Selection aids

The opposite diagram allows a quick selection from five seal combinations.

Thus, the block cylinder S can be optimally adapted to the operating conditions, i.e. to

- the operating pressure 250 bar or 500 bar,
- the operating temperature up to 200 °C.

The sealing material must be selected taking the hydraulic oil into consideration:

NBR (nitrile butadiene rubber) for

- Hydraulic oil HLP (-30... +100 °C)
- Other liquids *) HFA, HFB, HFC (-10... +55 °C)

FKM (fluor caoutchouc) for

- Hydraulic oil HLP (-20... +100 °C)
- Highly inflammable hydraulic fluids*) HFD (-20... +200 °C)

*) see also data sheet A0.100

Available seal combinations dependent on the operating pressure and the operating pressure temperature

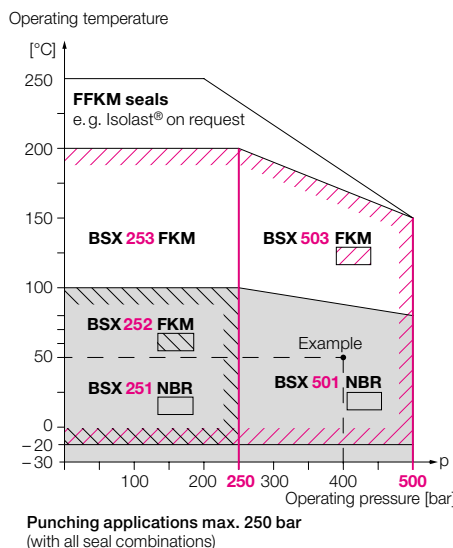

Example of ordering block cylinder S

Piston Ø 50 mm → as per chart code **6**

Operating pressure 400 bar → 500 bar = **50 MPa**

Operating temperature approx. 50 °C

with hydraulic oil HLP 32 → **NBR seals**

→ as per diagram type **BSX 501**

Pipe thread + 2 cross holes + 4 longitudinal holes

→ as per dimension drawing on page 2 code **RB**

Stroke 75 mm → as per chart code **075N**

Part no.

BS 6 501 RB 075 N1

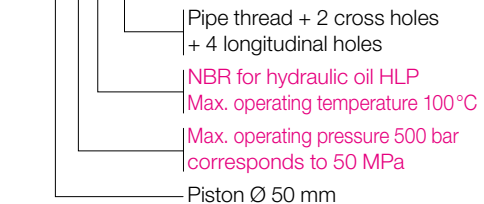

Code for part numbers see page 6

Flange with O-ring sealing

Broad side F

Rod side S

Bottom side B

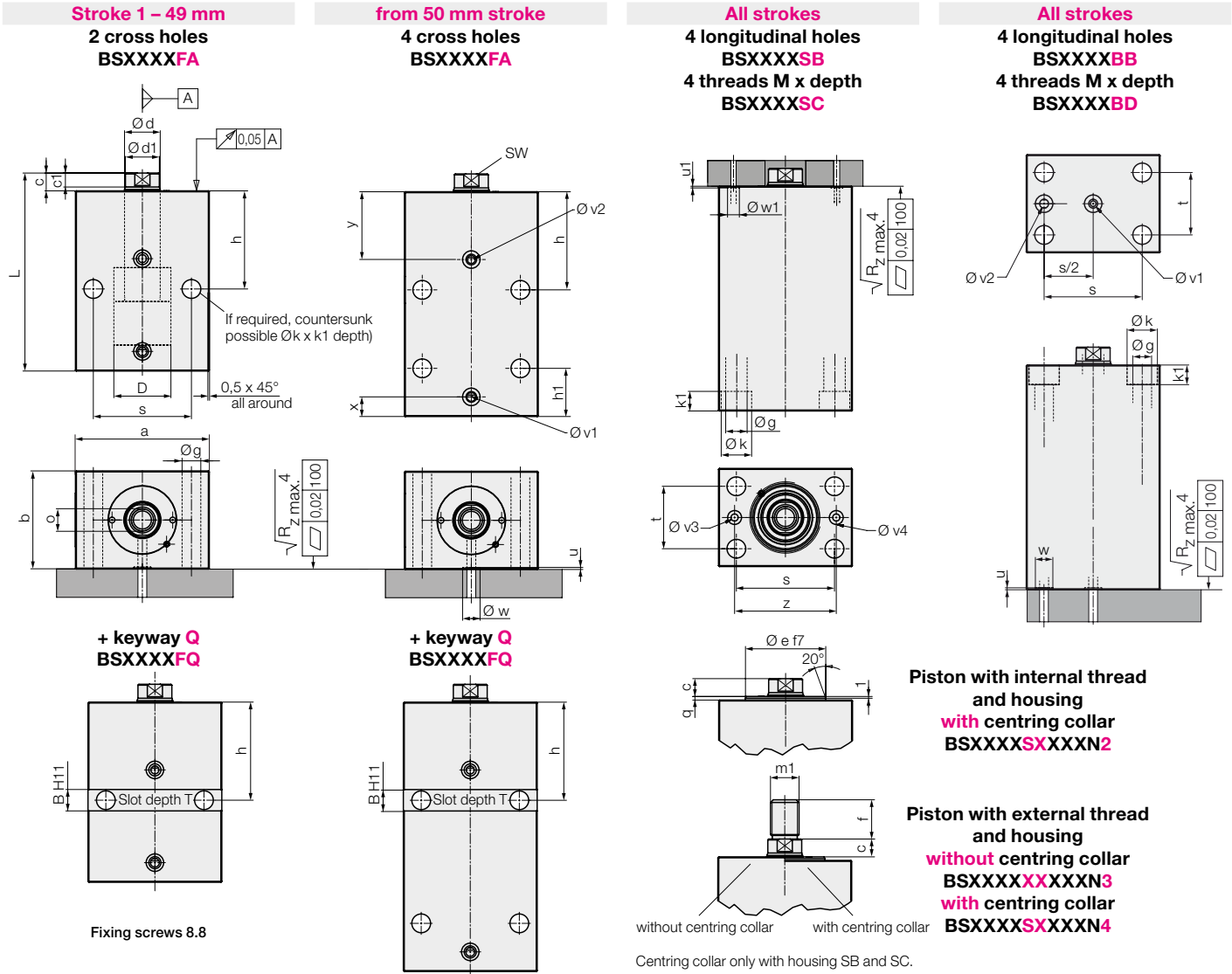

Size		4	5	6	7	8
Piston Ø D	[mm]	32	40	50	63	80
Rod Ø d	[mm]	20	25	32	40	50
Stroke ± 0.4	[mm]	25	25	25	25	25
Total length L +0.7/-0.3	[mm]	111	116	127	145	159
Weight, approx.	[kg]	2.7	3.7	5.7	10	18.2
Part no.		BS4XXXXX025NX	BS5XXXXX025NX	BS6XXXXX025NX	BS7XXXXX025NX	BS8XXXXX025NX
Stroke ± 0.4	[mm]	50	50	50	50	50
Total length L +0.7/-0.3	[mm]	136	141	152	170	184
Weight, approx.	[kg]	3.3	4.6	6.9	11.8	21.1
Part no.		BS4XXXXX050NX	BS5XXXXX050NX	BS6XXXXX050NX	BS7XXXXX050NX	BS8XXXXX050NX
Stroke ± 0.4	[mm]	75	75	75	75	75
Total length L +0.9/-0.5	[mm]	161	166	177	195	209
Weight, approx.	[kg]	4	5.4	8	13.6	24
Part no.		BS4XXXXX075NX	BS5XXXXX075NX	BS6XXXXX075NX	BS7XXXXX075NX	BS8XXXXX075NX
Stroke ± 0.4	[mm]	100	100	100	100	100
Total length L +0.9/-0.5	[mm]	186	191	202	220	234
Weight, approx.	[kg]	4.6	6.2	9.1	15.4	26.8
Part no.		BS4XXXXX100NX	BS5XXXXX100NX	BS6XXXXX100NX	BS7XXXXX100NX	BS8XXXXX100NX

Example of ordering see page 6

O-rings for flange surface (are included in the delivery)

Dimensions for F and B	[mm]	7x1.5	7x1.5	8x1.5	10x2	10x2
Part no.	NBR	3000342	3000342	3000343	3000347	3000347
Part no.	FKM	3001077	3001077	3000275	3001078	3001078
Dimensions for S	[mm]	5x1.5	5x1.5	7x1.5	10x2	10x2
Part no.	NBR	3000340	3000340	3000342	3000347	3000347
Part no.	FKM	3001147	3001147	3001077	3001078	3001078

Force to push and to pull

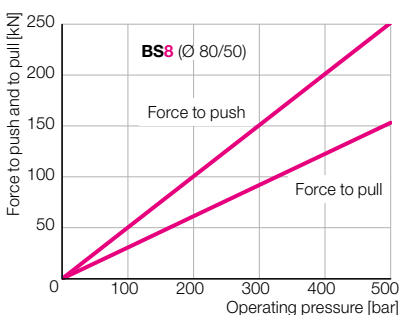
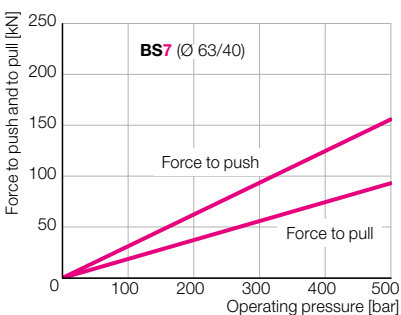
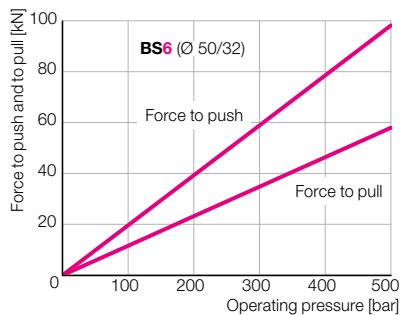
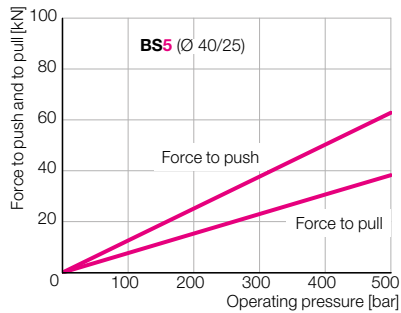
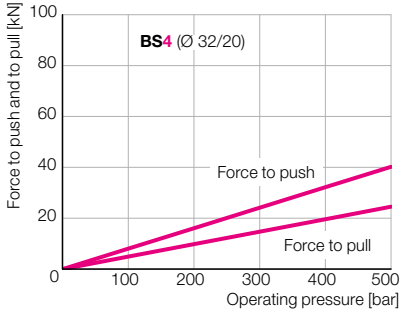
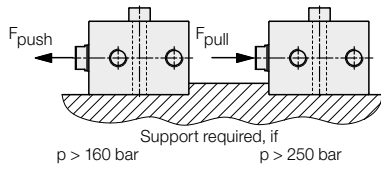

Internal piston stop

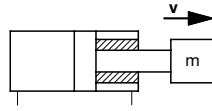

If the entire stroke of the block cylinder is used, the piston moves against the internal stops. The sudden load that occurs during this process is dependent on

- the piston speed v
- the mass m connected to the piston.

This series can withstand high mechanical loads. However, certain limit values should not be exceeded, as shown in the diagram below.

- The admissible piston speed can be read off at a given mass.
- The maximum mass can be determined for a given piston speed.

For continuous operation with a high number of strokes, the maximum mass should be reduced to approx. 10% of the values in the diagram.

Admissible piston speed v_{adm} as a function of the mass m fixed to the piston

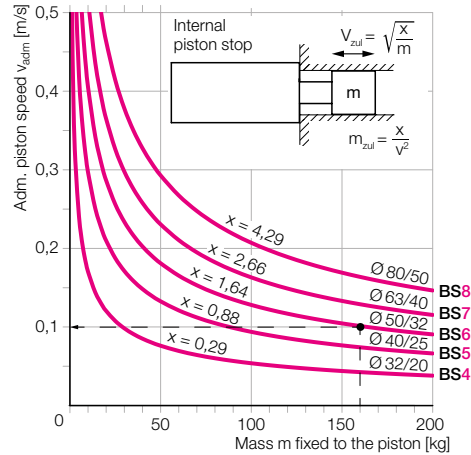

Example: BS6501RB075N1 (Ø 50/32 x 75 stroke)
 $m = 160 \text{ kg} \rightarrow v_{adm} = 0.1 \text{ m/s}$

Punching applications

Due to the cutting impact, the piston speed at the internal piston stop is usually not known. In such cases, an external stop is the better solution.

External stop of the mass

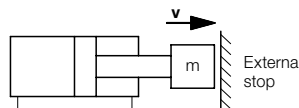

For critical designs and high number of strokes, it is better to drive the mass against external stops. They can be designed to be sturdy and, if required, even adjustable.

Stroke end cushioning

If an external stop is not possible, cylinders with hydraulic stroke end cushioning should be provided:

- Block cylinders 500 bar as per B 1.530
- Hydraulic cylinders 200 bar as per B 1.282
- Block cylinders S with hydraulic stroke end cushioning on request

Admissible piston side load

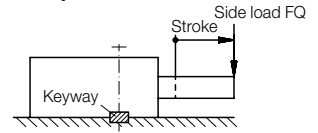

The admissible load is dependent on

- the distance of the side load from the cylinder housing
- the total stroke of the block cylinder
- the actual driven piston stroke
- the operating temperature
- the hydraulic fluid.

The diagrams show the admissible side load for each size under the following conditions:

- the side load acts directly on the end of the piston rod
 - the max. operating temperature is 80 °C
 - medium hydraulic oil HLP as per DIN 51524-2
- Please contact us for other operating conditions.

Important note

To ensure that the block cylinder S can safely absorb the side loads from all directions, the version with keyway should be used.

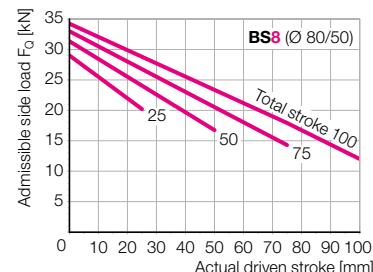
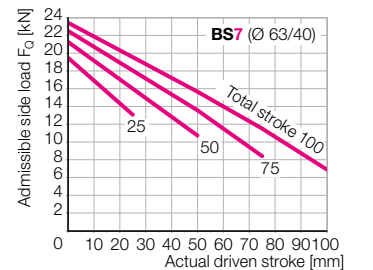
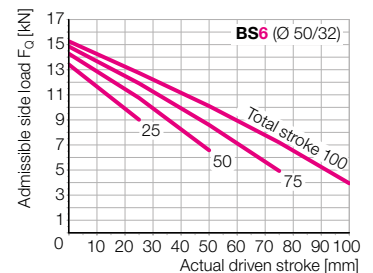
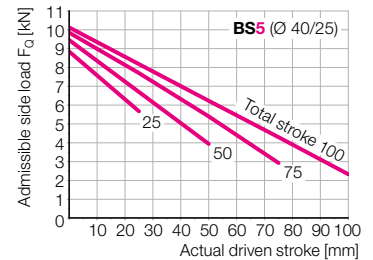
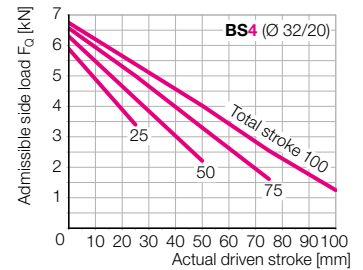

Example of ordering • Stroke limitation • Important notes

Example of ordering

Block cylinders S **BS 4 251 RA 025N 1**

Piston Ø:

4	32 mm
5	40 mm
6	50 mm
7	63 mm
8	80 mm

Piston thread, centring collar

- 1** Internal thread (standard)
- 2** Internal thread + centring collar (only with housing RB, RC, SB, SC)
- 3** External thread
- 4** External thread + centring collar (only with housing RB, RC, SB, SC)

Piston stroke (as per chart page 2 and 4)

- 025N** 25 mm
- 050N** 50 mm
- 075N** 75 mm
- 100N** 100 mm
- ZZZH** Special stroke ZZZ mm with stroke limitation by distance bushing (see example below)

Pipe thread R, fixation (page 2)

- RA** 2 cross holes
- RB** 2 cross holes + 4 longitudinal holes
- RC** 4 threads rod side
- RD** 4 threads bottom side
- RE** 2 cross holes + keyway, connection at the right side
- RF** 2 cross holes + keyway, connection at the left side

Flange-type connection F, S and B, fixation (page 4)

- FA** broad side, stroke 1 – 49 mm: 2 cross holes
from 50 mm stroke: 4 cross holes
- FQ** broad side, stroke 1 – 49 mm: 2 cross holes + keyway
from 50 mm stroke: 4 cross holes + keyway
- SB** rod side, 4 longitudinal holes
- SC** rod side, 4 threads
- BB** bottom side, 4 longitudinal holes
- BD** bottom side, 4 threads

Max. operating pressure, operating temperature, seals (see diagram page 3)

251	250 bar	-30 ... +100 °C	NBR	} for HFD liquids (fire-resistant)
501	500 bar*	-30 ... +100 °C	NBR	
252	250 bar	-20 ... +100 °C	FKM	
253	250 bar	-20 ... +200 °C	FKM	
503	500 bar*	-20 ... +150 °C	FKM	

*) For punching applications max. 250 bar

For further versions please ask for the request form "Block cylinder S".

Stroke limitation by distance bushing

By shrinking a distance bushing onto the piston rod, we can shorten the series stroke by 5 to 29 mm.

Standard stroke [mm]	Possible stroke ±0.5 [mm]	
	H min.	H max.
25	1 (10*)	20
50	21	45
75	46	70
100	71	95

*) For max. service life H min. ≥ 10 mm

Example of ordering

Block cylinder BS 6 501 RB 075N 1
Desired stroke 63 mm

The "standard stroke" is 75 mm
As per chart "Possible stroke" = 46 ... 70 mm
The distance bushing is 75 – 63 = 12 mm high

New part no. **BS 6 501 RB 063H 1**

Note on flange type F

A stroke limitation of the selected block cylinder does not change the number of cross holes (2 or 4 off).

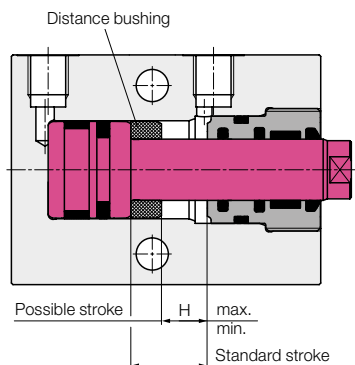

Important notes

Block cylinders are intended exclusively for industrial applications and may only be operated with hydraulic oil.

They can generate very high forces to be absorbed by the fixture or the machine.

In the effective area of the piston rod there is the danger of crushing. The manufacturer of the fixture or the machine is obliged to provide effective protection devices.

If block cylinders are fastened with screws across the cylinder axis, they must be supported above a specific operating pressure (see page 5 "Force to push and to pull").

If the piston moves against the internal piston stops in the block cylinder, the admissible piston speed must be reduced depending on the mass fixed to the piston (see page 5 "Internal piston stop").

For punching applications, the operating pressure must be limited to 250 bar to avoid extremely high loads due to the "cutting impact". This also applies to the high-pressure version BS50.

If the exact load on the internal piston stop cannot be calculated, an external stop should be provided for the tool (see page 5 "External stop of the mass").

When the piston rod is loaded by side loads, the admissible piston side load must be determined as a function of the piston stroke (see page 5 "Admissible piston side load").