



Magnetic sensors for position monitoring of block cylinders and pneumatic swing clamps



Advantages

- Compact design, minimum space requirement
- Adjustable switching points by displacement of the sensor
- Monitoring of several positions
- Indifference to shock and vibration
- Bounce-free output signal
- Only one switching point
- Wear resistant
- Protected against reverse battery
- Protected against short circuits
- Sensor locking with 2 screws

Application

Magnetic sensors are used for position monitoring of block cylinders and pneumatic swing clamps of the following data sheets:

- Block cylinder with bronze housing B 1.553
- Block cylinder with aluminium housing B 1.554
- Block cylinder with guide housing B 1.738
- Pneumatic swing clamp J 7.202

Monitoring of several positions

In the two lengthwise slots of the cylinder body several sensors can be fixed (depending on the length of the slot or the stroke).

In one slot, the minimum distance between the switching points is 6 mm; with two slots it is 3 mm.

Influencing the magnetic field with adjacent, magnetisable components (e.g. steel parts)

In order to guarantee perfect functioning, it is recommended to maintain a distance of at least 25 to 30 mm between magnetic sensor and magnetisable components. The function is indeed possible with a smaller distance but this depends highly on the individual circumstances for fitting. Thus ordinary steel bolts can also normally be used for fastening the cylinder. In borderline cases, screws of non-magnetisable steel (e.g. VA screws) can cause an improvement in the magnetic field.

Influencing the magnetic field with adjacent magnetic sensors

If several cylinders with magnetic sensors are installed directly adjacent to one another, the magnetic sensors can have a reciprocal influence and malfunctions occur. Troubles of functioning can occur. A magnetisable steel sheet can help, placed between the cylinders or magnetic sensors as a shield.

Demands on voltage supply

Frequently a simple two-phase bridge connection is used, as it is often used for contactor or relay control. Such a connection is not suitable for voltage supply of position monitorings! In figure 1 the progression of the output voltage of such a connection is represented over time. You can recognise that the voltage obtains temporarily the zero point. An electronic system could not function correctly in this case. In addition, you see that the peak values of the voltage exceed considerably their mean value. The electronic can be destroyed by too high peak spikes.

Usually voltmeters or multimeters measure the mean value of the voltage. The peak value is increased approx. by factor 1.5. A measure of quality of a d.c. voltage is the residual ripple. An ideal d.c. voltage, as it is generated by a battery, has a residual ripple of 0%, the above described two-phase bridge connection obtains a residual ripple of 48%. 10% is admissible!

The residual ripple can be improved by topping a sufficiently-designed capacitor. This is called "smoothing" of the voltage. But thereby the mean value of the d.c. voltage is increased. Therefore it is recommended to provide a "smoothed" voltage supply when planning an installation.

Incorrect:

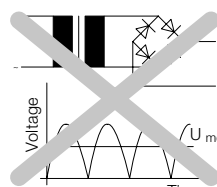

Correct:

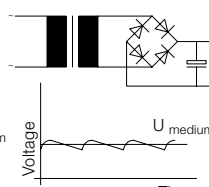
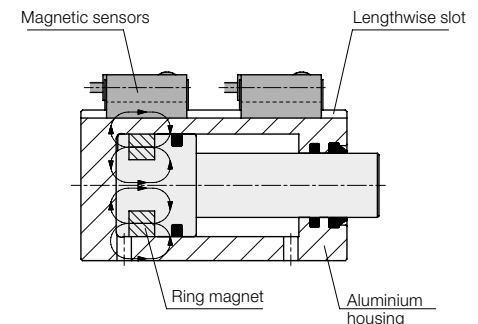

Figure 1: Generation of supply voltage

Function



Description/Function

Electronic magnetic sensors allow position monitoring of the pistons of cylinders with non-magnetisable housings (aluminium or bronze). An annular permanent magnet is fixed to the piston, and its magnetic field is detected by an electronic magnetic sensor.

The magnetic sensors are fixed outside in the lengthwise slots of the cylinder body. The switching points are adjustable by displacement of the magnetic sensors in the lengthwise slots of the body.

Spikes

A danger for position monitorings are elements with high inductivity, which are operated with the same voltage supply as the position monitorings. Such elements, as e.g. solenoid valves, contactors and motors can generate high and high-energy peak spikes, which are transmitted by the voltage supply to the position monitorings.

Therefore critical elements have to be screened. For this purpose recovery diodes or RC-networks are indicated, which are mounted directly at the sources of interference. An alternative solution is the separated voltage supply for position monitorings and critical consumers.

Application examples

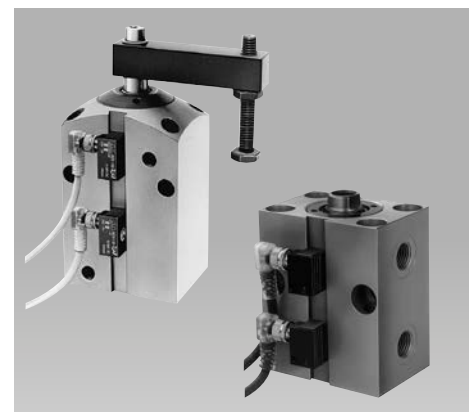

Dimensions

Technical data • Accessories

Dimensions

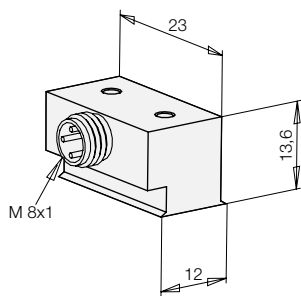

Technical data

Body material	aluminium black anodised	
Voltage	10 – 30 V DC	
Residual ripple	max. 10%	
Current load I_{LOAD}	200 mA – up to 50 °C 150 mA – at 75 °C 100 mA – at 100 °C	
Current consumption	< 15 mA	
Voltage drop (max. load)	< 2 V	
Protected against short circuits	yes	
Protection against reverse battery	installed	
Switching frequency	1 kHz	
Switching hysteresis	3 mm	
Protection as per DIN 40050	IP 67	
Environmental temperature	–25 °C up to +100 °C	
Port	M8 plug	
LED	no	
Output (interlock)	pnP	npn
Part no. (1 off)	3829234	3829240

Electric connection

Electric connection is made as per traditional inductive proximity switches. Up to four magnetic sensors can be connected in series.

Switching hysteresis of approx. 3 mm and path

This has to be considered already when adjusting the magnetic sensors. For static pistons, the magnetic sensor must always be pushed forward to the piston from the opposite direction.

Magnetic sensors with short path are available on request.

Connecting scheme

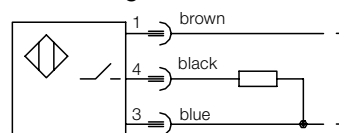

pnP = plus switching

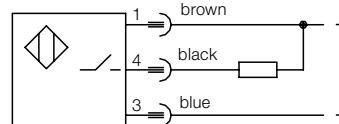

npn = minus switching

Temperature curve

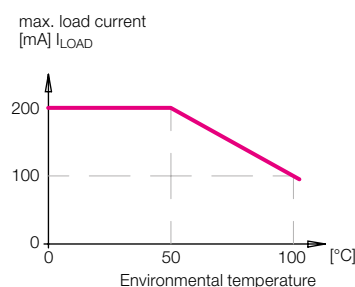

Maximum operating temperature

- Magnetic sensor +100 °C
- Permanent magnet: +100 °C
- Connecting cable with right angle plug: +90 °C

Magnetic sensors for an operating temperature up to 120°C are available on request.

Connecting cable

With angle plug M8



Technical data

Port	M8 plug, knee-type	
Voltage	10 – 30 V DC	
Protection as per DIN 40050	IP 67	
Environmental temperature	– 25 °C to +90 °C	
LED: Voltage	(green)	
Function display	(yellow)	
Cable, length of cable	PUR, 5 m	
Output (interlock)	pnP	npn
Part no. (1 off)	3829099	3829124

Y-distributor pnp

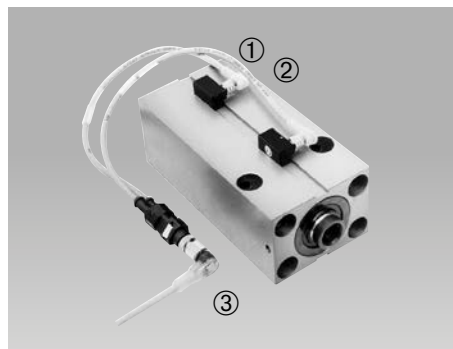

The Y-distributor allows connection of two proximity switches or magnetic sensors at a four-pole plug-type connector M12. For each cylinder only one cable has to be placed.

For easier adjustment of the switching points the right angle plugs M8 are equipped with two LEDs each, which indicate the operating voltage and the switching position. Plug-type connector M12 is equipped with three LEDs.

- ① Y-distributor knee-type, each 2 LED, 0.3 m
Part no. 3829 118
- ② Y-distributor straight, without LED, 0.3 m
Part no. 3829 125
- ③ Plug-type connector M12, 4 poles, 3 LED, 5 m
Part no. 3829 106

With pnp angle plug M12



- ① M12 knee-type, 2 LED, 3 m
Part no. 3829049
- ② M12 straight, without LED, 3 m
Part no. 3829078

Technical data

Voltage	10 – 30 V DC	
Protection as per DIN 40050	IP 67	
Environmental temperature	– 25 °C to +90 °C	
LED: Voltage	(green)	
Function display	(yellow)	