

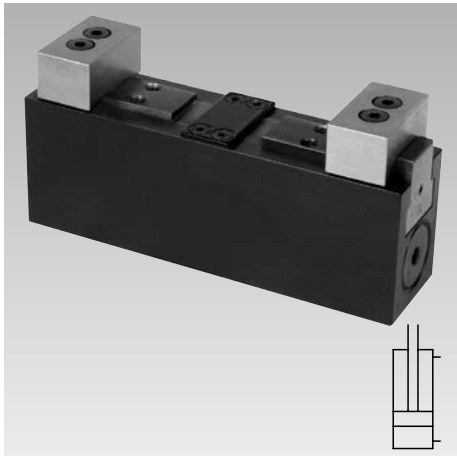

Fixture Clamp, Position Flexible

max. clamping force 8 kN, jaw width 40 mm
double acting, max. operating pressure 250 bar



Advantages

- Very compact design
- High stiffness
- High clamping force with low contact forces
- Position flexible within the clamping range
- Double-acting function
- Fixtures without pipes possible
- Exchangeable jaws
- Good swarf protection
- Port for central lubrication
- Mounting position: any

Function

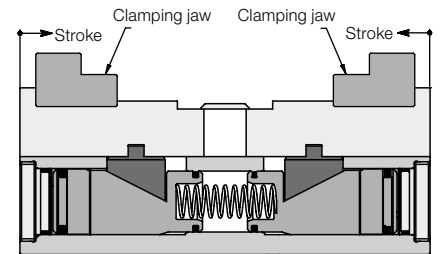

Application

Position-flexible fixture clamps can additionally clamp and support a workpiece, which is already positioned and clamped in fixed stops, at unstable workpiece sections. Due to their compact design they can be arranged in a very limited space. Fixture clamps are especially suitable for series manufacturing in automated mode. The double-acting cylinder function combined with central lubrication and good swarf protection guarantees a high process safety.

Fixing from above

with accessory adaptor plate
Drilled channels

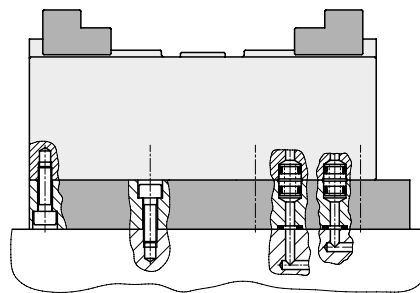

Fixing from below

Drilled channels

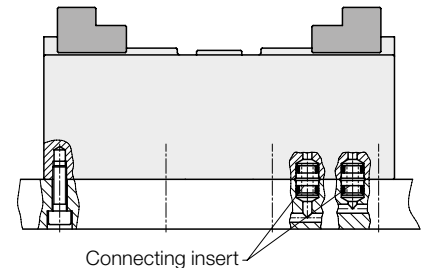

Description

The fixture clamp with position-flexible clamping function consists of a very slim basic body with 2 integrated hydraulic cylinders.

The piston forces are transmitted by two channels to the two clamping slides that can be moved independently from each other. During clamping both clamping slides contact the workpiece nearly without force (see page 3).

Only after that the clamping pressure and thereby the clamping force increases. Due to wedging of the clamping slides these are protected against displacement. Thereby the workpiece is floatingly held without deformation.

All threads and ports are at the bottom to allow a space-saving arrangement of several clamping points in a very limited space. If fixing from below is not possible an adaptor plate for manifold mounting or tube connection is available.

As accessory also blanks of clamping jaws are available for adaptation to the workpiece contour.

Pipe thread

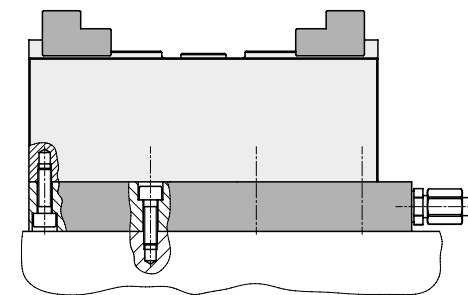

Application example

Clamping fixture for a pedal of a freight vehicle.

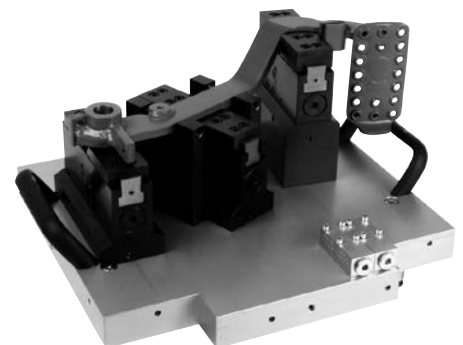

Accessories

Clamping jaws and adaptor plate are not included in the delivery of the fixture clamp and have to be ordered separately as accessory.

Clamping principle

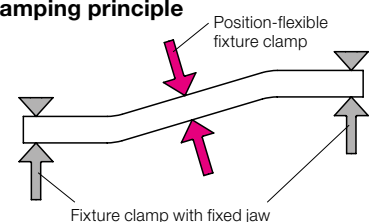

Part no. 4413080

Technical data

Clamping force at 250 bar	[kN]	8
Retention force at 250 bar	[kN]	10
Min. operating pressure	[bar]	25
Min. unclamping pressure	0,5 x clamping pressure	
Clamping stroke	[mm]	2 x 8
Jaw width	[mm]	40
Max. flow rate*	[cm ³ /s]	17
Stroke volume Clamping	[cm ³]	8.4
Unclamping	[cm ³]	7
Weight	[kg]	approx 2.5

* See page 3 "Position-flexible clamping"

Accessory: Adaptor plate

View from below

Adaptor plate (accessory)

Weight	[kg]	approx. 1,9
Part no.		0441305

Clamping force diagram

(Height of the clamping jaw 15 mm)

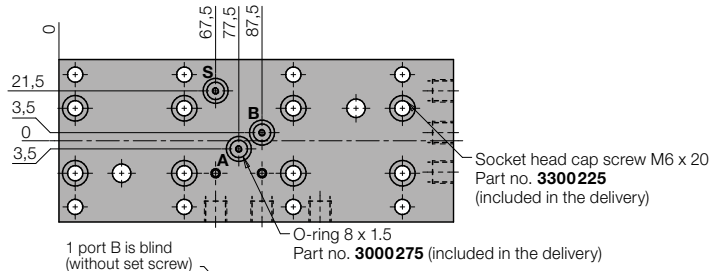
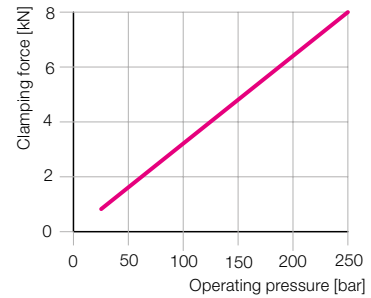

- A = Clamping
- B = Unclamping
- S = Central lubrication

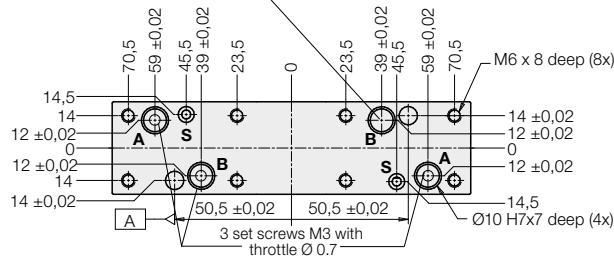

Clamping and unclamping
each Ø10 H7 x 7 deep for 4 x connecting insert **9210132** (included in the delivery), see also page F 9.300

Central lubrication
2 x with O-ring **3000876** (3.68x1.78 mm) (included in the delivery)

Important note!

If the fixture clamp is manifold-mounted without adaptor plate, all 5 ports (2xA, 1xB, 2xS) have to be individually connected.

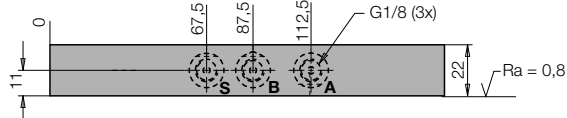
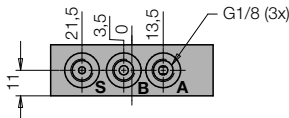
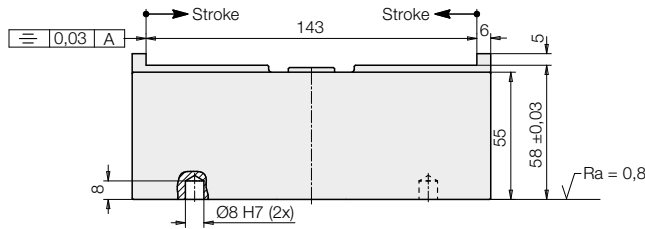
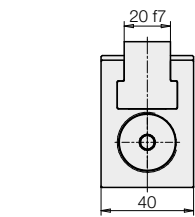

Accessory: Adaptor plate

Side views

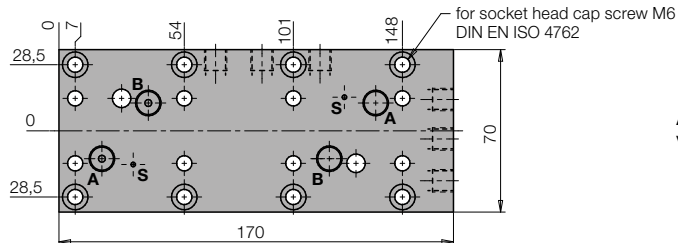
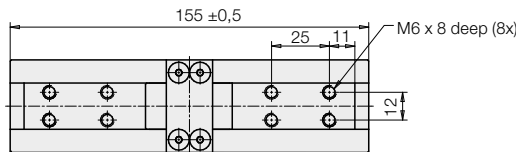

Accessory: Adaptor plate

View from above

Important notes!

The fixture clamp is only suitable for exterior clamping.

Lubricate the clamping slide via the central lubrication at the latest after 500 clamping cycles. (Recommended: slide way oil ISO 69)

Never use the complete clamping stroke to guarantee safe clamping of the workpiece.

Max. operating temperature 80 °C.

Operating conditions and other data see data sheet A 0.100.

Accessories

Position-flexible clamping

Self-made clamping jaws

Clamping jaws are manufactured according to the contour of the workpiece to be clamped. The max. height of the clamping jaw X at 250 bar operating pressure is indicated in the opposite chart.

If the operating pressure is lower, the clamping jaws can be designed higher as per the opposite diagram.

Max. height of the clamping jaws X at max. operating pressure of 250 bar

Fixing screws	M6x16 - 12.9
for clamping jaws	
X [mm] with 2 screws	15
X [mm] with 4 screws	36

Important note

The clamping jaws must always be supported by the provided support, since the fixing screws are not in the position to compensate the generated clamping forces.

Max. height of the clamping jaw X as a function of the operating pressure

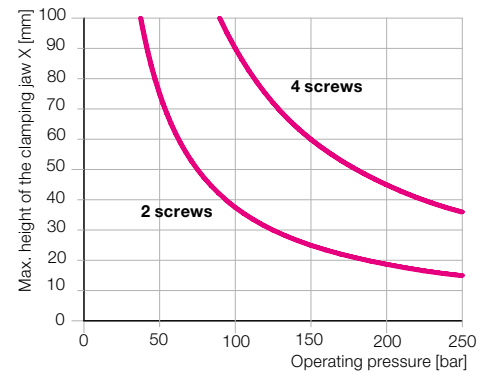

Clamping jaw blank 40 mm Part no. 3548070

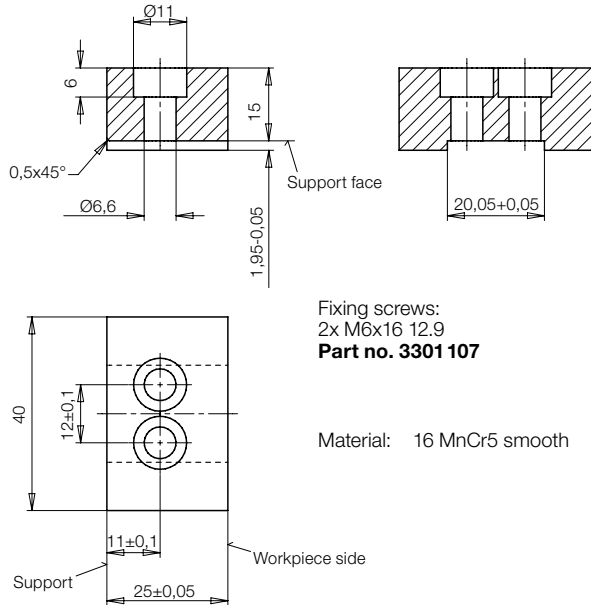

Fixing of the clamping jaws

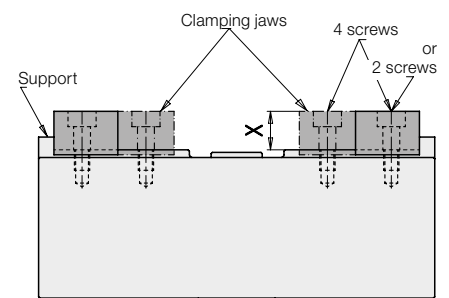

Position-flexible clamping

1. Position of the workpiece within the clamping range

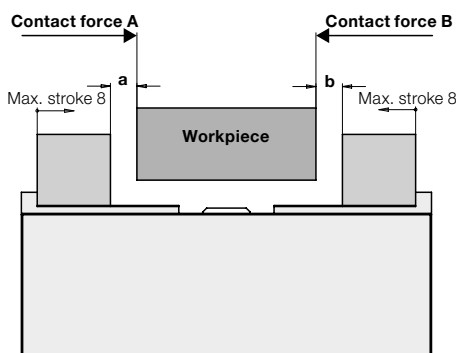

Limit dimensions: a max. = 7 mm
b max. = 7 mm

Recommendation:

Place the position-flexible fixture clamp as symmetrically as possible to the workpiece, so that the clamping jaws realise approximately the same stroke and also the smallest possible stroke.

2. Possible contact forces during clamping

Due to the slightly different factors of friction and an internal bracing spring the two clamping jaws do not uniformly contact the workpiece. One clamping jaw always hurries on ahead. This can already lead in case of very unstable sections to a deformation. The possible contact force can be taken from the diagram.

3. Max. flow rate

With a max. flow rate of $17 \text{ cm}^3/\text{s}$ the clamping time is approx. 0.5 seconds. For unstable workpieces and / or heavy clamping jaws the flow rate in the supply line should be throttled so that the clamping jaws contact the workpiece as „smoothly“ as possible. If required, the two set screws M3 ($\varnothing 0.7$) in the ports A can be replaced.

Contact force as a function of the stroke difference (a-b) or (b-a)

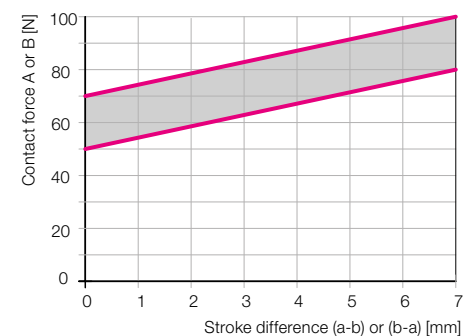

Diagram valid for horizontal mounting position. For vertical arrangement the weight of the clamping jaws has to be considered.