



Power Supply for Mobile Systems

Control module with battery holder for *modulog* modules



Advantages

- Off-grid power supply
- Use in mobile systems
- Compact design
- No downtime
- Fast charging
- High process times by powerful battery
- Long service life
- Ergonomic design
- Safe and precise handling
- Modular system with many possible combinations
- Integrated protection functions
- Protection against deep discharge

Application

The individual components are used for power supply for mobile systems in industrial assembly. They are suitable for electro-mechanical lifting modules or linear actuators with 24 V.

Fixing and installation

The control module with battery holder can be fixed with two screws M8 to the provided threads in the lifting modules at the outer profiles.

The supply line of the electrical actuator and the operating element are plugged in at the carrier plate of the control module.

Installation example

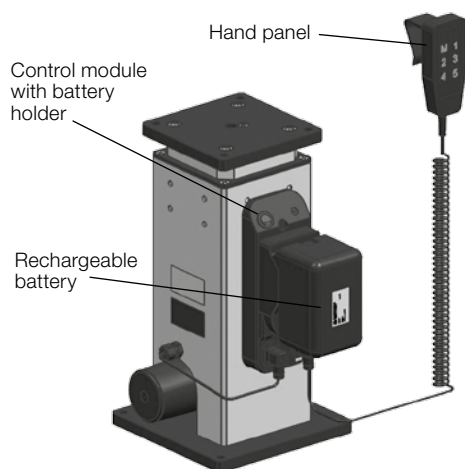

Description

A system with different individual components allows a network-independent power supply for electrical lifting modules. A rechargeable battery supplies the drive unit with energy. The battery can be recharged by an external quick battery charger.

In order to guarantee working without downtime, it is recommended to have a second rechargeable battery.

Control modules with battery holder for a single module are used to control lifting modules. Various operating elements allow an efficient functionality.

The following items are required for an operational system.

- Rechargeable battery
- Control module with battery holder
- Operating element
- Quick battery charger

Variants

The standard variant provides the functions "up/down" in touch control.

All variants are designed for the operation with lifting modules with **code letter B or I**.

The integrated electronic ensures in combination with the stroke measuring system of the lifting modules a soft start and stop to protect all components.

Also, current limitation and duty cycle limitation help to increase the service life.

Further variants of the control modules with battery holder allow the functions of storable intermediate positions for reproducible approach. On request, the functions synchronization control and individually preset stroke end positions are possible.

modulog

Power supply for mobile systems

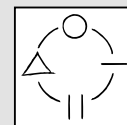

Technical data

Voltage	24 V
Capacity	4.5 Ah

Part numbers

Rechargeable battery	3822 184
Quick battery charger	3822 177
Control module standard	3821 270
with memory function	3821 270M

Combinable with the modules

- Lifting module – electro-mechanical as per data sheet M 4.202, M 4.301, M 4.401, M 4.501 **with code letter B or I**



- Cart module WMS as per data sheet M 5.101



- Linear actuator – electro-mechanical as per data sheet L 1.101 **with code letter I**

- Electrical operating elements, lines and connectors as per data sheet M 8.203

Material

All essential elements are made of shock-resistant plastic to obtain a high robustness.

Control module with battery holder for *modulog* lifting modules



Advantages

- Microprocessor controlled
- Controlled positioning in stroke end positions and memory positions
- Soft start
- Protective functions:
Electronic current limitation, overcurrent cut-off, detection of blockades, duty cycle limitation
- Charge state warning via LED
- Extensive fault diagnostic
- Fault signalling via flash code

modulog

Control module with battery holder

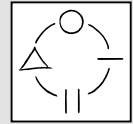

for 1 *modulog* module with incremental stroke measuring system

Part no. 3821 270

Accessories

- Electrical operating elements, cables and connectors as per data sheet M 8.203

Dimensions

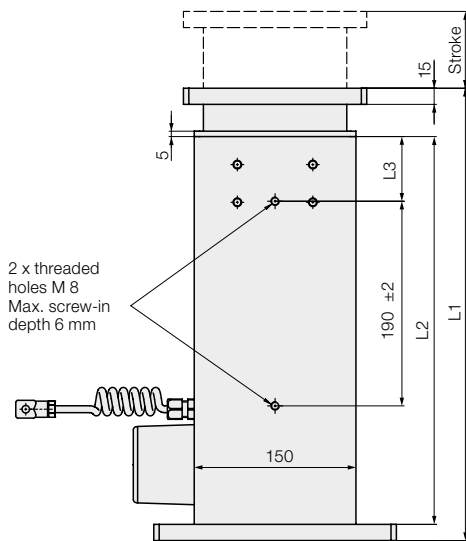

Stroke [mm]	L1 [mm]	L2 [mm]	L3 [mm]
200	420	360	60
300	520	460	135
400	620	560	185
500	720	660	235
600	820	760	285

Description

The control module with battery holder is the key element of the system to which all further components are connected. It is suitable for a lifting module with different force levels / stroke lengths and incremental stroke measuring system. The holder for the rechargeable battery is already integrated in the control module and forms a compact unit for supply and control of the drive module. The control unit in the control module has connections for the lifting module, for one operating element and control signals for optional functions.

Optional function:

The **memory function** allows to store up to five height positions. These can be recalled again and again or newly stored. Thus ergonomically reasonable working heights can be obtained for different persons or different working heights within one assembly process can be determined. Operation is made via an operating panel that allows to store the height positions as well as to call them. Due to safety reasons a movement is always made by touch control.

modulog

Control module with battery holder with memory function

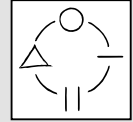

for 1 *modulog* module with incremental stroke measuring system

Part no. 3821 270M

Accessories

- Electrical operating elements, cables and connectors as per data sheet M 8.203

Technical data

Operating voltage (battery)	25.2 V
Electronic current limitation	8 A
Duty cycle	15 %, 1.5 min ON
Protection class	III
Code class (in mated condition)	IP 30
Standby current consumption	approx. 7 mA
Electrical connections	Plug connection secured by screw
Weight	approx. 700 g

Fixing and installation

Fixation and installation of the control module can be carried out directly at the lifting module in prepared bore holes.



modulog
Rechargeable battery

Part no. 3822 184

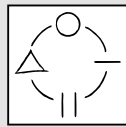

Description

The rechargeable battery is a Li-Ion battery and is used with its 25.2 V and 4500 mAh for ROEMHELD lifting modules as an energy source. The high capacity in a compact housing allows an efficient and flexible use.

Important notes

For charging of the batteries exclusively the quick battery charger part-no. 3822 177 from ROEMHELD may be used.

Technical data

Nominal voltage	25.2 V
Nominal capacity	4500 mAh
Charging current	max. 3A
Operating temperature	
Charging	10 °C ... + 40 °C
Operating temperature	
Discharging	0 °C ... + 50 °C
Storage temperature	-20 °C ... + 35 °C
Dimensions (L x W x H)	135 x 85 x 91 mm
Weight	approx. 860 g

Capacity of the rechargeable battery

Based on the following diagrams, the possible number of cycles with a completely charged battery can roughly be determined. They are presented as a function of the different force levels and stroke lengths using an individually-operated lifting module as an example.

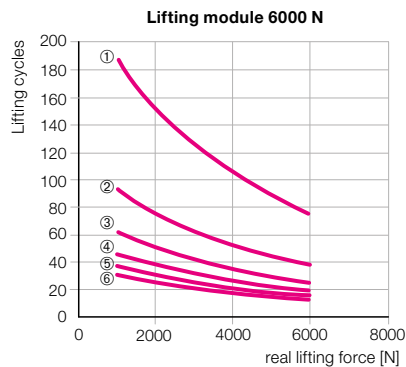
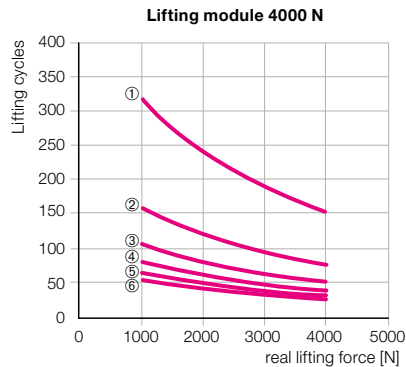
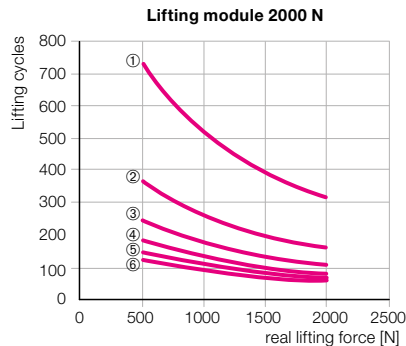
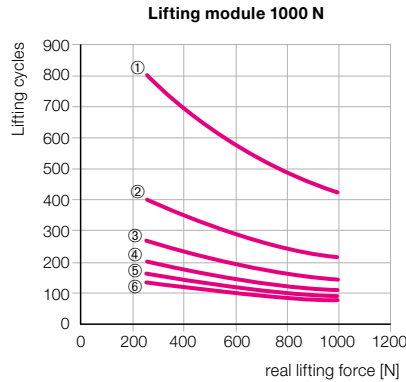

- ① = 100 mm stroke
- ② = 200 mm stroke
- ③ = 300 mm stroke
- ④ = 400 mm stroke
- ⑤ = 500 mm stroke
- ⑥ = 600 mm stroke



modulog
Quick battery charger

Part no. 3822 177



Description

The quick battery charger is used to recharge the rechargeable battery (part-no. 3822 184).

Technical data

Supply voltage	220 ... 240 V ± 10 %
Frequency of the supply voltage	50 ... 60 Hz
Output voltage	9.6 ... 28.8 V
Charging current	2.9 A ± 10 %
Power limitation	max. 55 ... 70 W
Charging time for 4.5 Ah	approx. 2 h
Ambient temperature	
Storage	-20 °C ... + 60 °C
Ambient temperature	
Operation	+ 5 °C ... + 40 °C
Protection class	II
Code class	IP 30
Dimensions (L x W x H)	152 x 86 x 76 mm
Weight	approx. 550 g

Variants

Quick battery charger for use at 100 ... 120 VAC 50 ... 60 Hz

Part no. 3822 182

Important notes

The battery charger is equipped with a Euro plug. A plug adaptor is country-specific required.